



Burner controls

LME7...

The burner control LME7... is a microprocessor-based unit with matching system components for the control and supervision of forced draft burners of medium to high capacity.

The LME7... and this Data Sheet are intended for use by OEMs which integrate the LME7... in their products.

Use

LME7... are used for the startup and supervision of multistage or modulating forced draft burners and atmospheric gas burners in intermittent operation

The fuel-air ratio can be set either via an air damper actuator - acting on mechanical or pneumatic ratio control - or via pulse width modulated fans and pneumatic ratio control.

The flame supervision supervised with ionization probe and with UV flame detector QRA2..., QRA4.U or QRA10....

- Gas burner controls to EN 298: 2003
- Oil burner controls to EN 230: 2005
- For gas forced draft burners to EN 676
- For oil burners with fan to EN 267

Notes



Caution!

All safety, warning and technical notes given in the Basic Documentation of the LME7... (P7105) also apply to this document! If not observed, there is a risk that safety functions will be impaired and that a risk of electric shock will exist!

Features

- Undervoltage detection
- Electrical remote reset facility
- Accurate control times thanks to digital signal handling
- Multicolor indication of fault status and operating state messages
- Air pressure supervision with function check of air pressure switch during start and operation
- Repetition limitation
- Controlled intermittent operation after 24 hours of continuous operation (can be parameterized via parameter 239) depending on program module PME...
- BCI
- Unit parameter adjustable either via display or PC software ACS410
- Connection for program module PME...

Only LME71.../LME73...:

- Indication of program sequence

Integrated in the basic unit LME7... are:

- Burner control
- BCI for connection a display or PC
- Lockout reset button (info button)
- 3 multi color signal lamp LED for operations and fault notifications
- Optional: Analog inputs for load controller DC 0...10 V, DC 0/4...20 mA, 0...135 Ω
- Interface for program module

Only LME71.../LME73...:

- Optional: 3 x 7 segment display for fault and state information's and parameter display
- Control for one actuator

Supplementary documentation

User Documentation LME73.000.../PME73.840.....	A7105
Environmental Product Declaration LME... ..	E7105
Environmental Product Declaration PME... ..	E7105.1
Basic Documentation LME7... ..	P7105
Product Overview LME... ..	Q7101

Standards and certificates



Conformity to EEC directives
- Electromagnetic compatibility EMC (immunity)
- Directives for gas-fired appliances
- Low-voltage directive

2004/108/EC
2009/142/EC
2006/95/EC



ISO 9001: 2010
Zert. 00739



ISO 14001: 2010
Zert. 38233



Only AC 120 V versions



Identification code to EN 298 chapter 4

- PME71.401...: F M C L J N
- PME71.402...: F B C L J N
- PME71.901...: F M C L G N
- PME72.521...: F M L L X N
- PME72.541...: F B L L X N
- PME73.810...: F M C L J N
- PME73.820...: F M C L J N
- PME73.830...: F B C L J N
- PME73.831...: F B L L J N
- PME73.840...: F B C L J N

Life cycle

Burner controls LME7... has a designed lifetime* of 250,000 burner startup cycles which, under normal operating conditions in heating mode, correspond to approx. 10 years of usage (starting from the production date given on the type field). This lifetime is based on the endurance tests specified in standard EN 230/EN 298 and the table containing the relevant test documentation as published by the European Association of Component Manufacturers (Afecor) (www.afecor.org).

The designed lifetime is based on use of the burner controls according to the manufacturer's Data Sheet and Basic Documentation. After reaching the designed lifetime in terms of the number of burner startup cycles, or the respective time of usage, the burner control is to be replaced by authorized personnel.

* The designed lifetime is not the warranty time specified in the Terms of Delivery

System overview

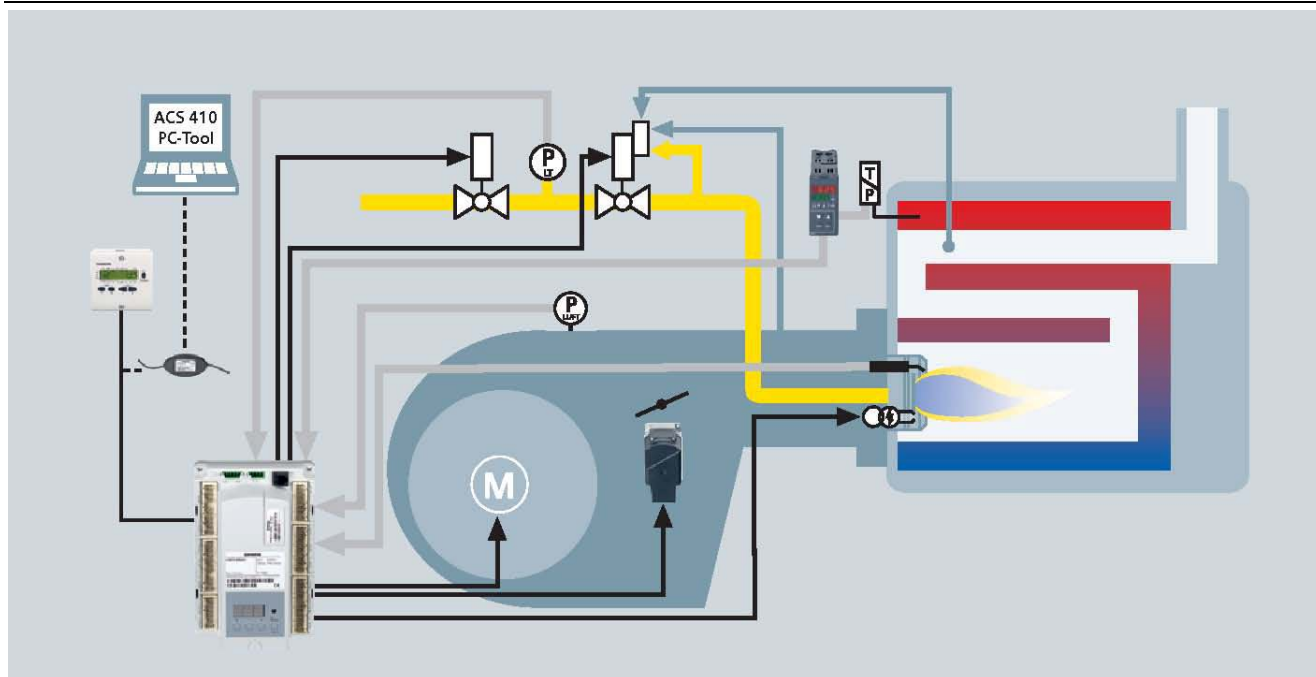

The diagram shows the full scope of functions of the LME7... system. The correct functions are to be determined based on the respective execution/configuration.

Type summary
Burner control

LME7...

Parameterized burner control for the supervision of multistage or modulating oil/gas forced draft burners and atmospheric burners of medium to higher capacity, in intermittent operation. With controlled air damper control. See Basic Documentation P7105



Type	LME71.000A1	LME71.000A2	LME72.000A2	LME73.000A1	LME73.000A2
Mains voltage AC 120 V	●	---	---	●	---
Mains voltage AC 230 V	---	●	●	---	●
Gas pressure switch-min/POC	●	●	●	●	●
Pressure switch valve proving	●	●	●	●	●
Air pressure switch	●	●	●	●	●
Ionization probe	●	●	●	●	●
QRA2.../QRA4.U/QRA10...	●	●	●	●	●
Load controller analog input signal (0...10 V, 4...20 mA, 0...135 Ω)	●	●	---	●	●
Load controller input 3-position step input/2-stage	●	●	●	●	●
Output actuator control	---	---	●	●	●
Input feedback for actuator with potentiometer 0...1 kΩ	---	---	---	●	●
Output PWM control	●	●	●	●	●
Onboard LED 7-segment display	●	●	---	●	●
BCI bus for AZL2...	●	●	●	●	●

Type summary (cont'd)

Program module

PME7...

Program module for LME7...
 With program sequences oil or gas burners for basic unit
 LME7...
 See Basic Documentation P7105



PME7... with mains voltage AC 120 V

Type reference	PME71.401A1	PME71.402A1	PME71.901A1	PME73.810A1	PME73.820A1	PME73.830A1	PME73.831A1	PME73.840A1
Mains voltage AC 120 V	●	●	●	●	●	●	●	●
For use with LME71.000A...	●	●	●	---	---	---	---	---
For use with LME72.000A...	---	---	---	---	---	---	---	---
For use with LME73.000A...	---	---	---	●	●	●	●	●
Gas program forced draft burner	●	●	●	●	●	●	●	●
Gas program atmospheric burner	---	---	---	---	---	---	---	---
1-stage/2-stage or 1-stage modulating	●	●	●	●	●	●	●	●
Pilot burner simultaneously/alternately	---	●	---	---	---	●	●	●
Modulating via actuator (pneumatic or mechanic gas-air ratio control)	---	---	---	●	●	●	●	●
Modulating via PWM fan (pneumatic or mechanic gas-air ratio control)	---	---	●	---	---	---	---	---
Fan speed control/control via analog signal/3-position step signal	---	---	●	---	---	---	---	---
Actuator control via analog signal/3-position step signal for actuator with potentiometer	---	---	---	●	---	●	●	---
3-position signal for actuator without potentiometer	---	---	---	---	●	---	●	●
Control sequence programmable time	●	●	●	●	●	●	●	●
POC	●	●	●	●	●	●	---	●
Valve proving	---	---	●	●	●	●	●	●
Input valve proving ON/Off	---	---	---	---	---	---	●	---

Type summary (cont'd)

PME7... with mains voltage AC 230 V

Type reference	PME71.401A2	PME71.402A2	PME71.901A2	PME72.521A2	PME72.541A2	PME73.810A2	PME73.820A2	PME73.830A2	PME73.831A2	PME73.840A2
Mains voltage AC 230 V	●	●	●	●	●	●	●	●	●	●
For use with LME71.000A...	●	●	●	---	---	---	---	---	---	---
For use with LME72.000A...	---	---	---	●	●	---	---	---	---	---
For use with LME73.000A...	---	---	---	---	---	●	●	●	●	●
Gas program forced draft burner	●	●	●	●	●	●	●	●	●	●
Gas program atmospheric burner	---	---	---	---	---	---	---	---	---	---
1-stage/2-stage or 1-stage modulating	●	●	●	●	●	●	●	●	●	●
Pilot burner simultaneously/alternately	---	●	---	---	●	---	---	●	●	●
Modulating via actuator (pneumatic or mechanic gas-air ratio control)	---	---	---	●	●	●	●	●	●	●
Modulating via PWM fan (pneumatic or mechanic gas-air ratio control)	---	---	●	---	---	---	---	---	---	---
Fan speed control/control via analog signal/3-position step signal	---	---	●	---	---	---	---	---	---	---
Actuator control via analog signal/3-position step signal for actuator with potentiometer	---	---	---	---	---	●	---	●	●	---
3-position signal for actuator without potentiometer	---	---	---	●	●	---	●	---	●	●
Control sequence programmable time	●	●	●	---	---	●	●	●	●	●
POC	●	●	●	●	●	●	●	●	---	●
Valve proving	---	---	●	---	---	●	●	●	●	●
Input valve proving ON/Off	---	---	---	---	---	---	---	---	●	---

Display/operating units and accessories

AZL21.00A9

Display and operating unit, detached, choice of mounting methods with LCD, 8-digit, 5 buttons, BCI for LME7..., degree of protection IP40.
See Data Sheet N7542



AZL23.00A9

Display and operating unit, detached, choice of mounting methods with LCD, 8-digit, 5 buttons, BCI for LME7..., degree of protection IP54.
See Data Sheet N7542



Built-in in the LME7...

3-colored LED, reset button (info button), 3 other buttons for operation in connection with 3 x 7-segment display

AGV50.100

Signal cable for AZL2..., with RJ11 connector, cable length 1 m, pack of 10



Flame detectors

QRA2...

UV flame detector for the supervision of gas flames and yellow-/blue-burning oil flames and for ignition spark proving. Plastic insulated housing, metalized to prevent static charging caused by the air flow from the fan, lateral illumination.
See Data Sheet N7712



QRA4.U

UV flame detector for the supervision of gas flames and yellow-/blue-burning oil flames and for ignition spark proving, metal housing, and frontal illumination.
See Data Sheet N7711



QRA10...

UV flame detector for supervision of gas flames and yellow-/blue-burning oil flames and for ignition spark proving. Die-cast aluminium housing with a 1 in. mounting coupling and connection facility for cooling air.
See Data Sheet N7712



Actuators

SQN3...

Electromotoric actuators for use with air dampers and control valves of oil or gas burners of small to medium capacity.

Holding torque/running time 0,8 Nm/4,5 s
up to 3 Nm/30 s

See Data Sheet N7808



SQN7...

Electromotoric actuators for air dampers and control valves of oil and gas burners of small to medium capacity.

Holding torque/running time 0,7 Nm/4 s
up to 2,5 Nm/30 s

See Data Sheet N7804



SQM40.../SQM41...

Electromotoric actuators for air dampers and control valves of oil and gas burners of medium to high capacity, with UL-registered.

Holding torque / running time 5 Nm/15 s
up to 10 Nm/30 s

See Data Sheet N7817



SQM5...

Electromotoric actuators for air dampers and control valves of oil and gas burners of medium to high capacity, with UL-registered.

Holding torque/running time 10 Nm/15 s
up to 40 Nm/60 s

See Data Sheet N7815



Pressure switch

QPLx5...

The pressure switch is used for monitoring of gas or air pressure.

See Data Sheet N7221



Dummy plug for RJ11

Dummy plug

For 6-pole modulating connector (RJ11)

Supplier recommendation: Molex,
order number: 085 999 3256

Type summary (cont'd)

Connector set for LME7...

AGG3.710
Connector set complete
RAST5 and RAST3.5
Single packs
See object list C7105 (74 319 0642 0)

AGG3.720
10 standard connector set complete
RAST5 and RAST3.5
Packing in bags of 10 pieces each connector type.
See object list C7105 (74 319 0642 0)

AGG3.730
50 standard connector set complete
RAST5 and RAST3.5
Packing in bags of 50 pieces each connector type.
See object list C7105 (74 319 0642 0)

Example: X5-03



Service tools

OCI410...
Interface between burner control and PC
Facilitates viewing, handling and recording setting parameters on site in connection with the PC software ACS410.
See Data Sheet N7616



ACS410
PC software for setting the parameters and for visualizing the burner controls.
See Software Documentation J7352

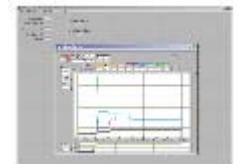

Test case and accessories

KF8895.1A9
Test case for LME...

- For simulations of burner functions as startups, sequences of operations in connection with the specified burner controls
- For check and test purposes of burner controls
- For operation in laboratories by expert qualified personnel

See User Manual U7993



AGV8895.01
Connection cable set for LME7...

- For test case KF8895.1A9
- Consisting of:

AGV8895.01X1
Connection cable for mains potential

- For test case KF8895.1A9



AGV8895.01X3
Connection cable for extra-low voltage, PELV

- For test case KF8895.1A9



Technical data

Basic unit LME7...

General

Mains voltage	AC 120 V	AC 230 V
Mains frequency	50/60 Hz	50/60 Hz
External primary fuse	Max. 6.3 A (slow)	Max. 6.3 A (slow)
Power consumption	<10 W, typical	<10 W, typical
Safety class	I with parts according to II and III to DIN EN 60730-1	
Degree of protection	IP00	



Note:
The burner or boiler manufacturer must ensure degree of protection IP40 for burner controls as per DIN EN 60529 through adequate installation of the LME7...

Perm. mounting position	Optional
Weight	Approx. 490 g

Terminal rating

Inputs

Mains voltage: Input current depending on the operating state of the unit		
Under voltage	UMains 120 V	UMains 230 V
<ul style="list-style-type: none"> Safety shutdown from the operating position takes place should mains voltage drop 	≤AC 75 V	≤AC 165 V
<ul style="list-style-type: none"> Restart is initiated when mains voltage exceeds 	≥AC 100 V	≥AC 195 V
State inputs, temperature controller, temperature switch, load controller, pressure switch, air pressure switch, actuator (except safety loop) of the contact feedback network are used for system supervision and require mains-related input voltage		
<ul style="list-style-type: none"> Input safety loop 	See Terminal rating outputs	
<ul style="list-style-type: none"> Input currents and input voltages 		
- UeMax	UN +10%	UN +10%
- UeMin	UN -15%	UN -15%
- IeMax	1.5 mA peak (peak value)	1 mA peak (peak value)
- IeMin	0.8 mA peak (peak value)	0.5 mA peak (peak value)
<ul style="list-style-type: none"> Contact material recommended for external signal sources (air pressure switch, pressure switch-min, pressure switch-max, etc.) 	Gold-plated silver contacts	
<ul style="list-style-type: none"> Transition/settling behavior/bounce 		
- Perm. bounce time of contacts when switching ON/OFF	Max. 50 ms (after the bounce time, the contact must stay closed or open)	
<ul style="list-style-type: none"> UN 	AC 120 V	AC 230 V
<ul style="list-style-type: none"> Voltage detection 		
- ON	>AC 60 V	>AC 120 V
- OFF	<AC 40 V	<AC 80 V
Analog input X65	DC 0...10 V/DC 0/4...20 mA/0...135 Ω	

Technical data (cont'd)

Terminal rating *Outputs*

Total contact loading:		
• Rated voltage	AC 120 V 50/60 Hz	AC 230 V 50/60 Hz
• Unit input current X3-04 (safety loop) from: - Fan motor contactor - Ignition transformer - Fuel valves	Max. 5 A	Max. 5 A
Individual contact loading:		
Fan motor contactor X2-01 pin 3		
• Rated voltage	AC 120 V 50/60 Hz	AC 230 V 50/60 Hz
• Rated current	2 A (15A max. 0.5 s)	2 A (15A for max. 0.5s)
• Power factor	$\text{Cos}\varphi \geq 0.4$	$\text{Cos}\varphi \geq 0.4$
Alarm output X2-03 pin 3		
• Rated voltage	AC 120 V 50/60 Hz	AC 230 V 50/60 Hz
• Rated current	1 A	1 A
• Power factor	$\text{Cos}\varphi > 0.6$	$\text{Cos}\varphi > 0.6$
Ignition transformer X4-02 pin 3		
• Rated voltage	AC 120 V 50/60 Hz	AC 230 V 50/60 Hz
• Rated current	2 A	2 A
• Power factor	$\text{Cos}\varphi > 0.4$	$\text{Cos}\varphi > 0.4$
Auxiliary output		
• Rated voltage	AC 120 V 50/60 Hz	AC 230 V 50/60 Hz
• Rated current	1 A	1 A
• Power factor	$\text{Cos}\varphi > 0.6$	$\text{Cos}\varphi > 0.6$
Output relay contact K2 X2-09 pin 7		
• Rated voltage	AC 120 V 50/60 Hz	AC 230 V 50/60 Hz
• Rated current	1 A	1 A
• Power factor	$\text{Cos}\varphi > 0.4$	$\text{Cos}\varphi > 0.4$
Fuel valves/pilot valve X7-01 pin 3		
• Rated voltage	AC 120 V 50/60 Hz	AC 230 V 50/60 Hz
• Rated current	1 A	1 A
• Power factor	$\text{Cos}\varphi > 0.4$	$\text{Cos}\varphi > 0.4$
Fuel valves 1 X7-04 pin 4/ fuel valve 2 X7-02 pin 3		
• Rated voltage	AC 120 V 50/60 Hz	AC 230 V 50/60 Hz
• Rated current	2 A	2 A
- Valve proving inactive	1 A	1 A
- Valve proving active	1 A	1 A
• Power factor	$\text{Cos}\varphi > 0.4$	$\text{Cos}\varphi > 0.4$
 Note:	When activating valve proving (e.g. on shutdown), the load on the valve terminals is restricted. If the load is not reduced, the design lifetime is about 100,000 burner start cycles!	
Safety valve X6-03 pin 3		
• Rated voltage	AC 120 V 50/60 Hz	AC 230 V 50/60 Hz
• Total current	1.5 A	1.5 A
• Power factor	$\text{Cos}\varphi > 0.6$	$\text{Cos}\varphi > 0.6$
Safety loop X3-04 pin 2, safety valve X6-03 pin 3, POC X2-02 pin 3		
• Rated voltage	AC 120 V 50/60 Hz	AC 230 V 50/60 Hz
• Total current	2 A	2 A
• Power factor	$\text{Cos}\varphi > 0.4$	$\text{Cos}\varphi > 0.4$

Technical data (cont'd)

Cable lengths	Mains supply line	Max. 100 m (100 pF/m)
	Display, BCI	For use under the burner hood or in a control panel Max. 1 m (100 pF/m)
	Load controller X5-03	Max. 30 m (100 pF/m)
	Safety Loop	Max. 30 m (100 pF/m)
	Safety valve	Max. 30 m (100 pF/m)
	Fuel valve	Max. 30 m (100 pF/m)
	Ignition transformer	Max. 30 m (100 pF/m)
	Remote reset (lay separate cable)	Max. 30 m (100 pF/m)
	Other lines	Max. 30 m (100 pF/m)

Specification as per EN 60730-1

Type of shutdown or interruption of each circuit

Shutdown with microswitch 1 pole

Mode of operation Type 2 B

Actuators	CLOSE/ignition position/OPEN	1 mio. switching cycles	1 mio. switching cycles
	X2-09 pin 1, X2-09 pin 2, X2-09 pin 3		
	• Rated voltage	AC 120 V 50/60 Hz	AC 230 V 50/60 Hz
	• Rated current	0,1 A	0,1 A
	• Power factor	Cosφ >0.6	Cosφ >0.6

Cross-sectional areas

The cross-sectional areas of the mains power lines (L, N, and PE) and, if required, the safety loop (safety limit thermostat, water shortage, etc.) must be sized for rated currents according to the selected external primary fuse.

The cross-sectional areas of the other cables must be sized in accordance with the internal unit fuse (max. 6.3 AT).

Min. cross-sectional area	0.75 mm ² (single- or multicore to VDE 0100)
---------------------------	--

Cable insulation must be suited for the respective temperature and environmental conditions!

Technical Data (cont'd)

Signal cable AGV50... AZL2... → BCI	Signal cable	Color white Unshielded Conductor 4 x 0.141 mm ² With jack RJ11
	Cable length AGV50.100	1 m
	Supplier (alternative)	Recommendation: Hütter http://www.hkt-netzwerktechnik.at/index.htm
	Location	Under the burner hood (arrangements for SKII EN60730-1 additionally required)
Dummy plug for RJ11	Dummy plug	For 6 pin modular plug (RJ11)
	Supplier	Recommendation: Molex Order no.: 085 999 3256
Environmental conditions	Storage	DIN EN 60721-3-1
	Climatic conditions	Class 1K3
	Mechanical conditions	Class 1M2
	Temperature range	-40...+70 °C
	Humidity	<95% r.h.
	Transport	DIN EN 60721-3-2
	Climatic conditions	Class 2K3
	Mechanical conditions	Class 2M2
	Temperature range	-40...+70 °C
	Humidity	<95% r.h.
	Operation	DIN EN 60721-3-3
	Climatic conditions	Class 3K3
Mechanical conditions	Class 3M2	
Temperature range	-40...+60 °C	
Humidity	<95% r.h.	



Warning!

Condensation, formation of ice and ingress of water are not permitted!
If not observed, there is a risk of impairment of safety functions and of electric shock hazard.

Flame supervision with ionization probe

No-load voltage at terminal ionization probe (X10-05 pin 2)	AC 300 V
---	----------



Warning!

- The ionization probe must be protected against electric shock hazard!
- When monitoring ionization currents in earth-free mains, connect terminal X10-05 pin 1 to burner ground

Short-circuit current	Max. AC 1 mA
Required detector current	Min. DC 1 µA, display approx. 20%
Possible detector current	Max. DC 40 µA, display approx. 100%
Permissible length of detector cable (laid separately)	30 m (core-earth 100 pF/m)

Note:

As the detector line capacitance (line length) increases, the voltage at the ionization probe and thus the detector current will drop. Extremely long line lengths and very high-ohmic flames might necessitate the use of low-capacitance cable (e.g. ignition cable). In spite of special electronic circuits designed to compensate possible adverse effects of the ignition spark on the ionization current, it must be made certain that the minimum detector current required is already available during the ignition phase. If this is not the case, the primary ignition transformer connections must be interchanged and/or the electrodes relocated.



Threshold values when flame is supervised by ionization

- | | |
|---------------------------------------|---|
| - Start prevention (extraneous light) | - Intensity (parameter 954) approx. 12% |
| - Operation | - Intensity (parameter 954) approx. 13% |

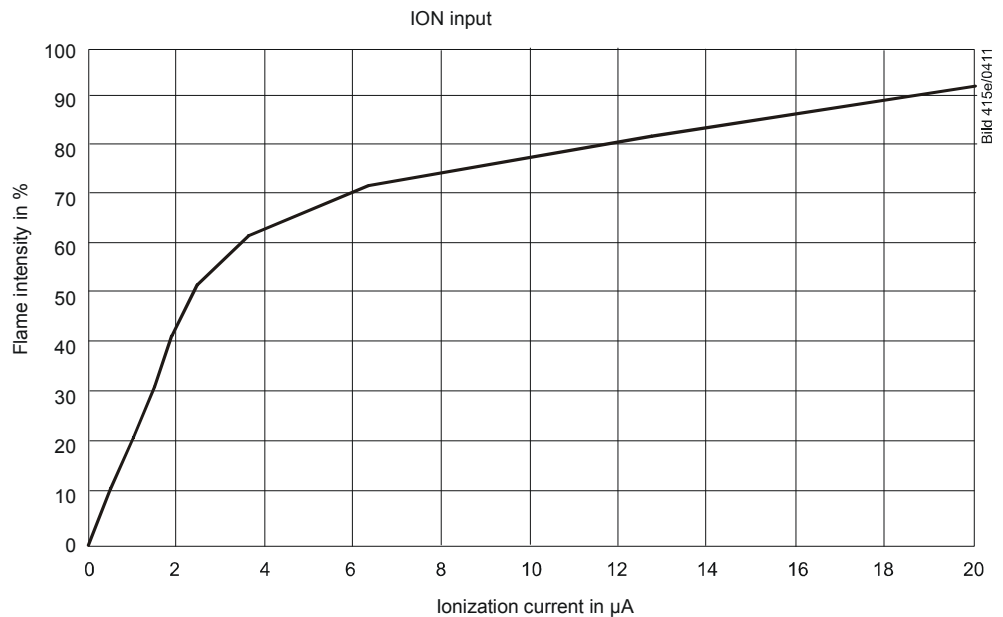

Measuring circuit for
detector current
measurement

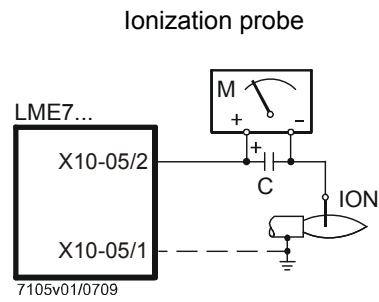

Legend

- C Electrolytic condenser 100...470 μ F; DC 10...25 V
- ION Ionization probe
- M Microammeter R_i max. 5,000 Ω



Warning!
Simultaneous operation of QRA... and ionization probe is not permitted!
If not observed, there is a risk of impairment of safety functions.

Flame supervision with
QRA2... / QRA4.U /
QRA10...



Caution!

If flame detectors QRA2.../QRA4.U/QRA10... are used for flame supervision with the LME7..., it must be ensured that the burner control is permanently connected to power (conforming to EN 298), thus enabling the system to detect flame detector failures during startup and shutdown.

Generally, the system works with flame detectors QRA... in intermittent operation. If this is not observed, there is a risk of loss of safety functions.

Technical Data see Data Sheet N7712, flame detector QRA2.../QRA10...!

Technical Data see Data Sheet N7711, flame detector QRA4.U!

Threshold values when flame is supervised by QRA...	
- Start prevention (extraneous light)	- Intensity (parameter 954) approx. 12%
- Operation	- Intensity (parameter 954) approx. 13%
Operating voltage	AC 280 V ±15%
Mains frequency	50...60 Hz ±6%
Required detector current in operation	Min. 70 µA
Possible detector current in operation	Max. 700 µA
Perm. length of detector cable (normal cable, laid separately) ¹⁾	Max. 100 m

¹⁾ Multicore cable not permitted

Measuring circuit for
detector current
measurement

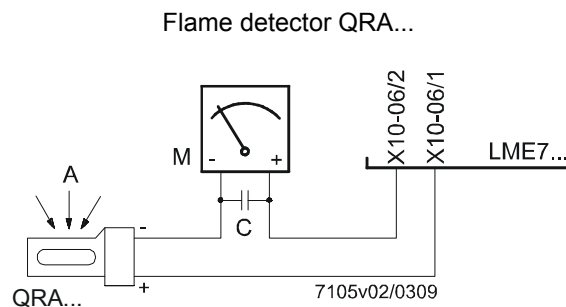

Legend

- A Exposure to light
- C Electrolytic condenser 100...470 µF; DC 10...25 V
- M Microammeter Ri max. 5,000 Ω



Warning!

- **Input QRA... is not short-circuit-proof!**
Short-circuits of X10-06 pin 2 against earth can destroy the QRA... input
- **Simultaneous operation of flame detector QRA... and ionization probe is not permitted.** If not observed, there is a risk of impairment of safety functions.
- **To make certain the age of the UV tube can be determined, the LME7... basic unit must always be connected to mains supply.** If not observed, there is a risk of impairment of safety functions.

Connection diagram LME71... for PME71.401...

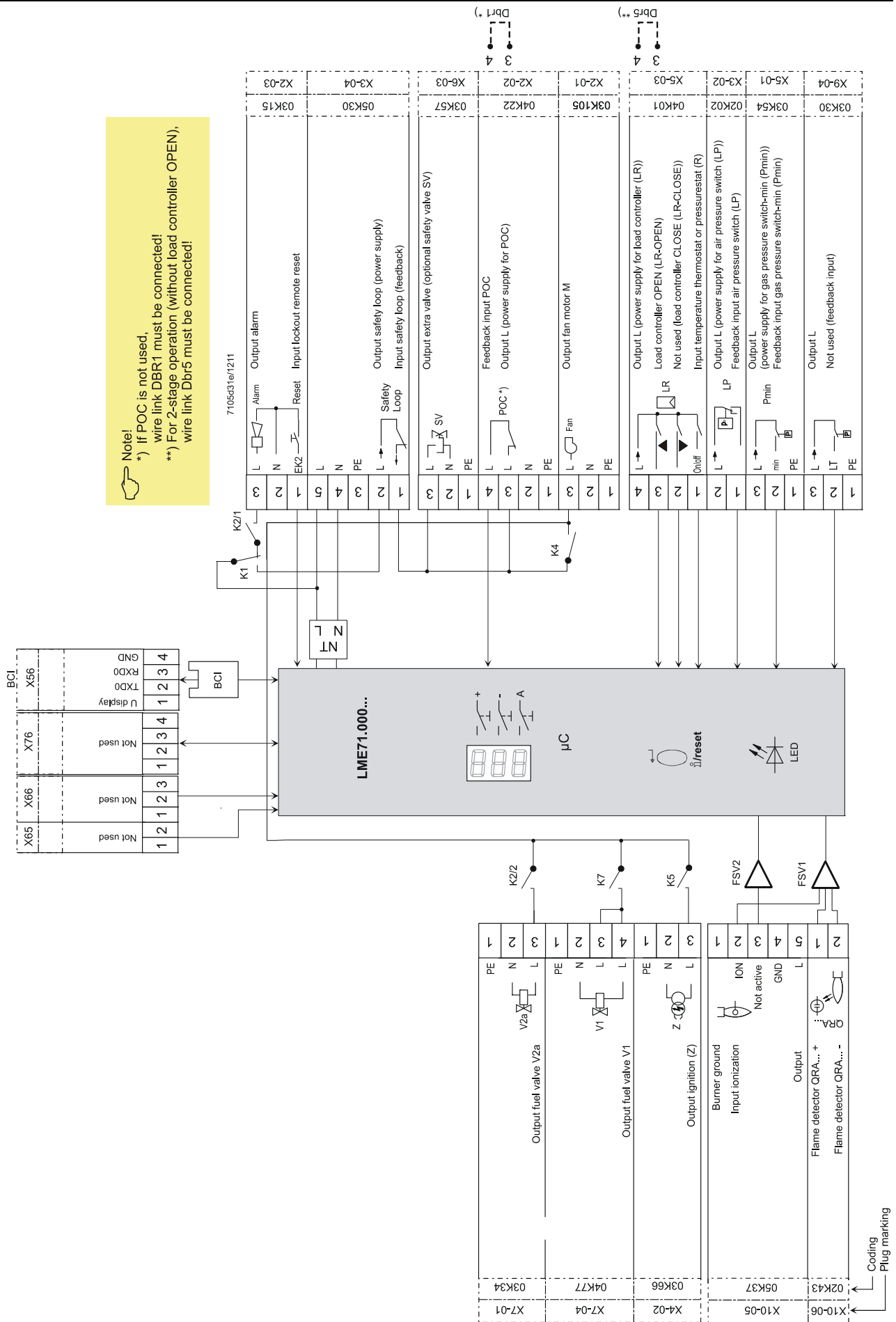

Connection diagram LME71... for PME71.402...

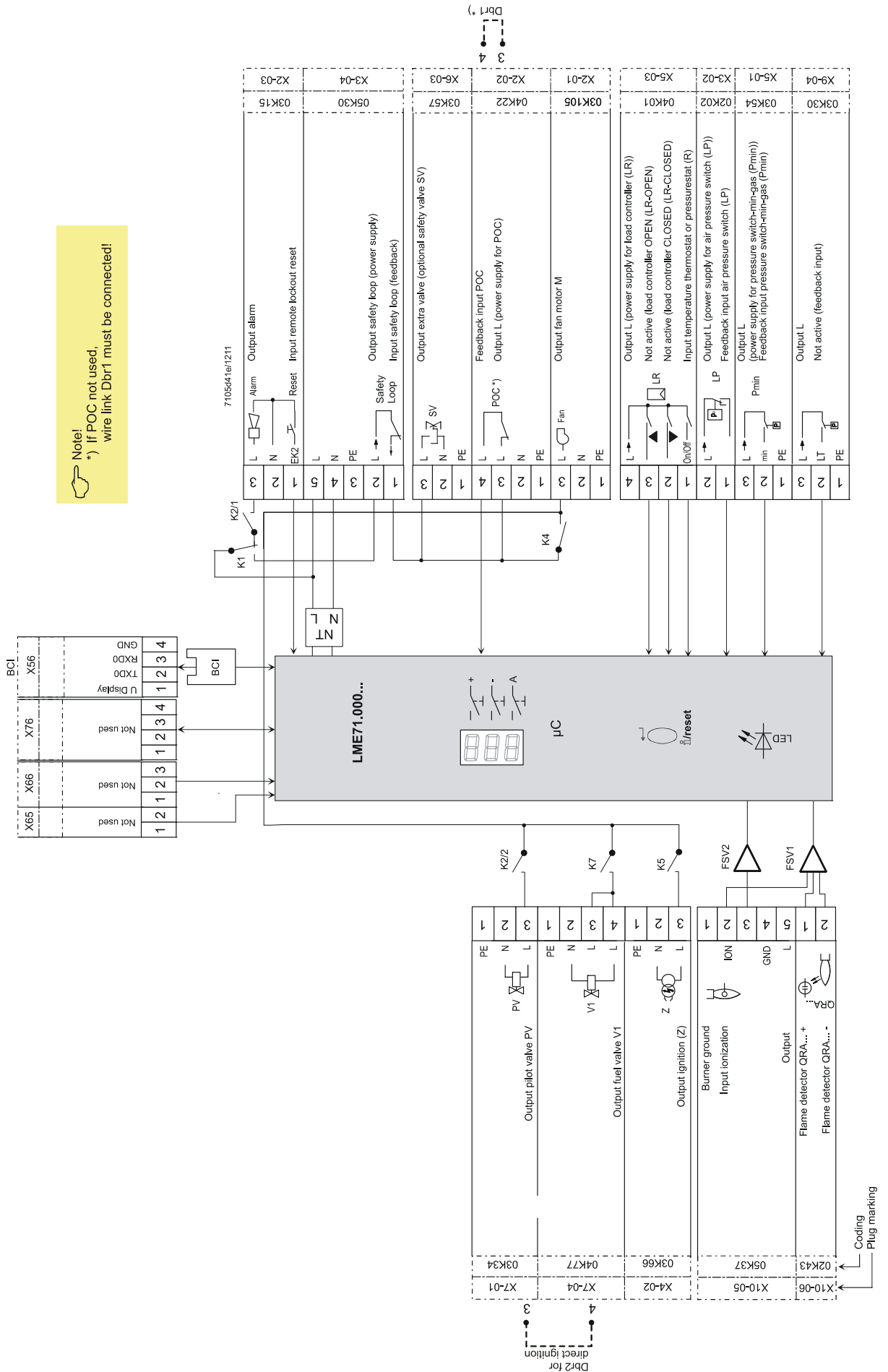

Connection diagram LME71... for PME71.901...

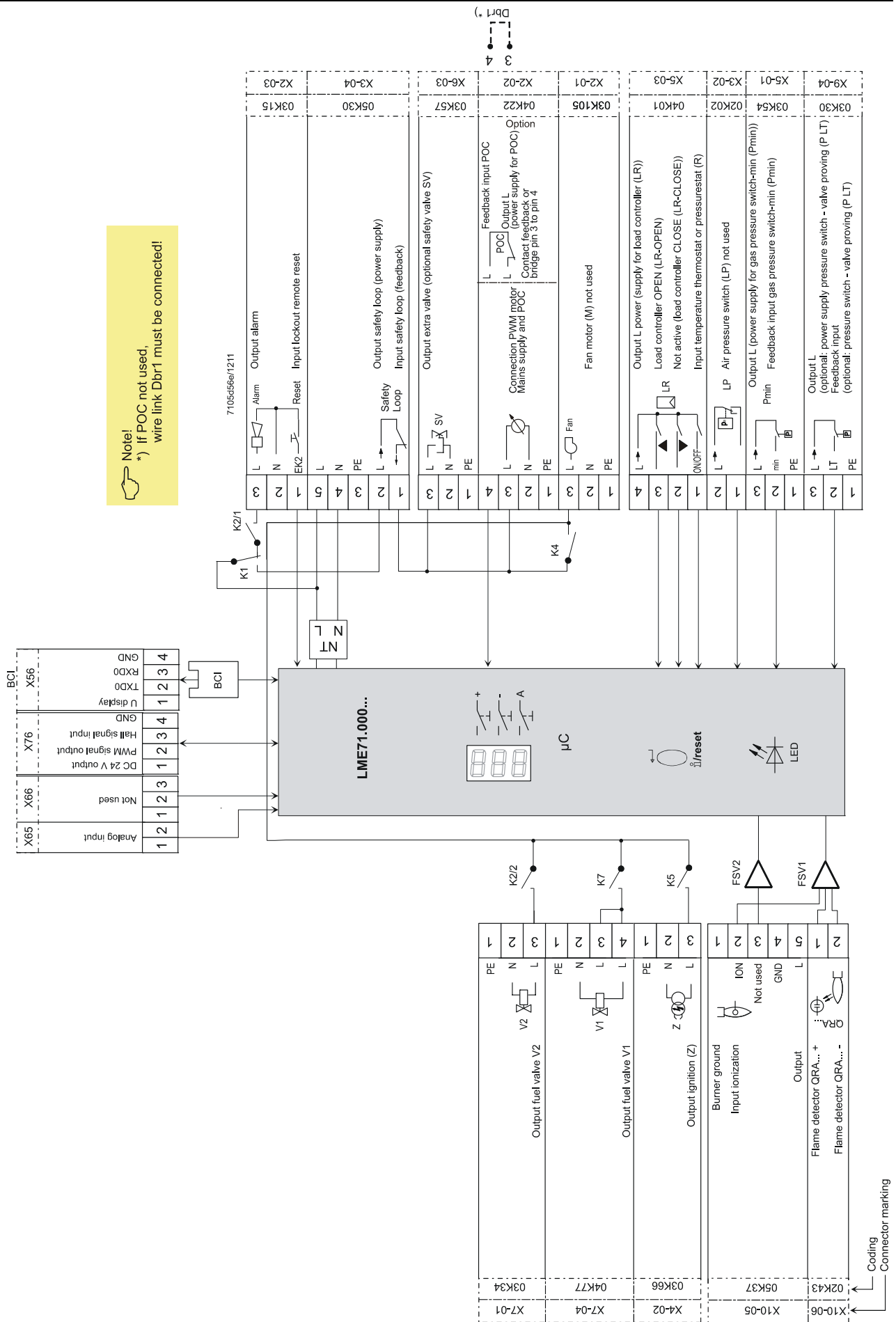

Note!
*) if POC not used,
wire link Dbr1 must be connected!

Connection diagram LME72... for PME72.521...

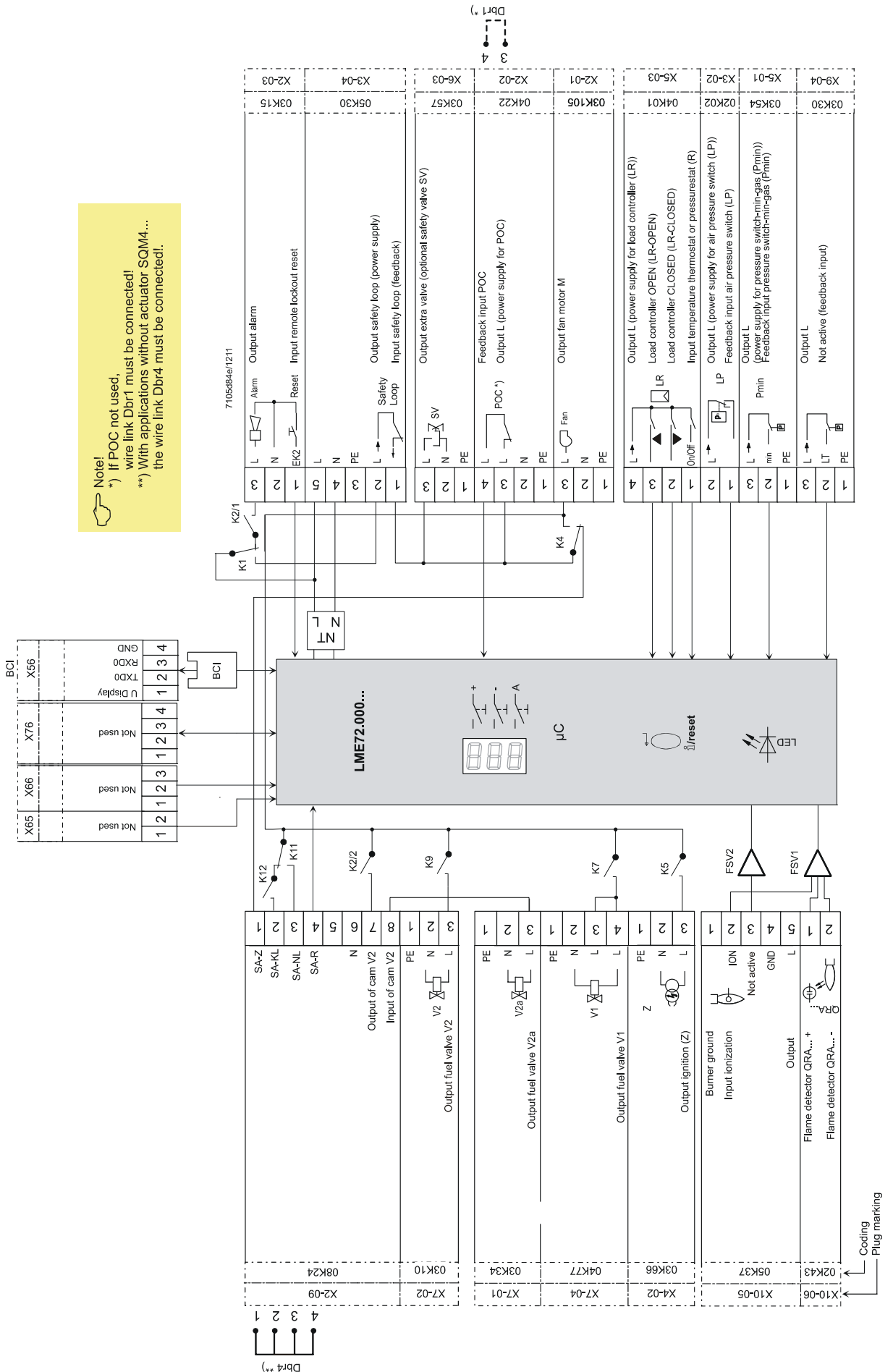

Connection diagram LME72... for PME72.541...

Note:
 *) If POC not used, the wire link Dbr1 must be connected!
 **) With applications without actuator SQM4..., the wire link Dbr4 must be connected!

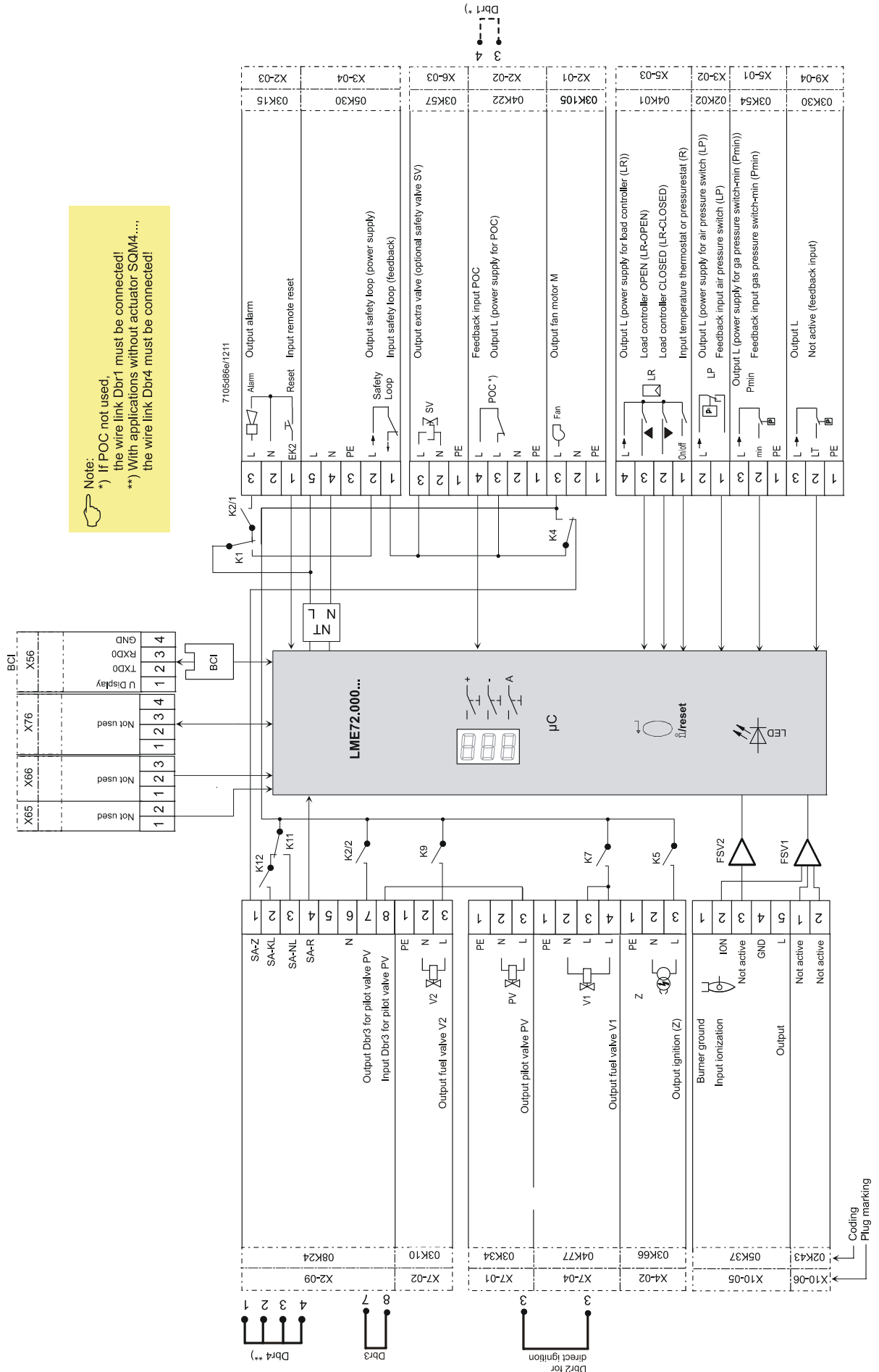

Connection diagram LME73... for PME73.810...

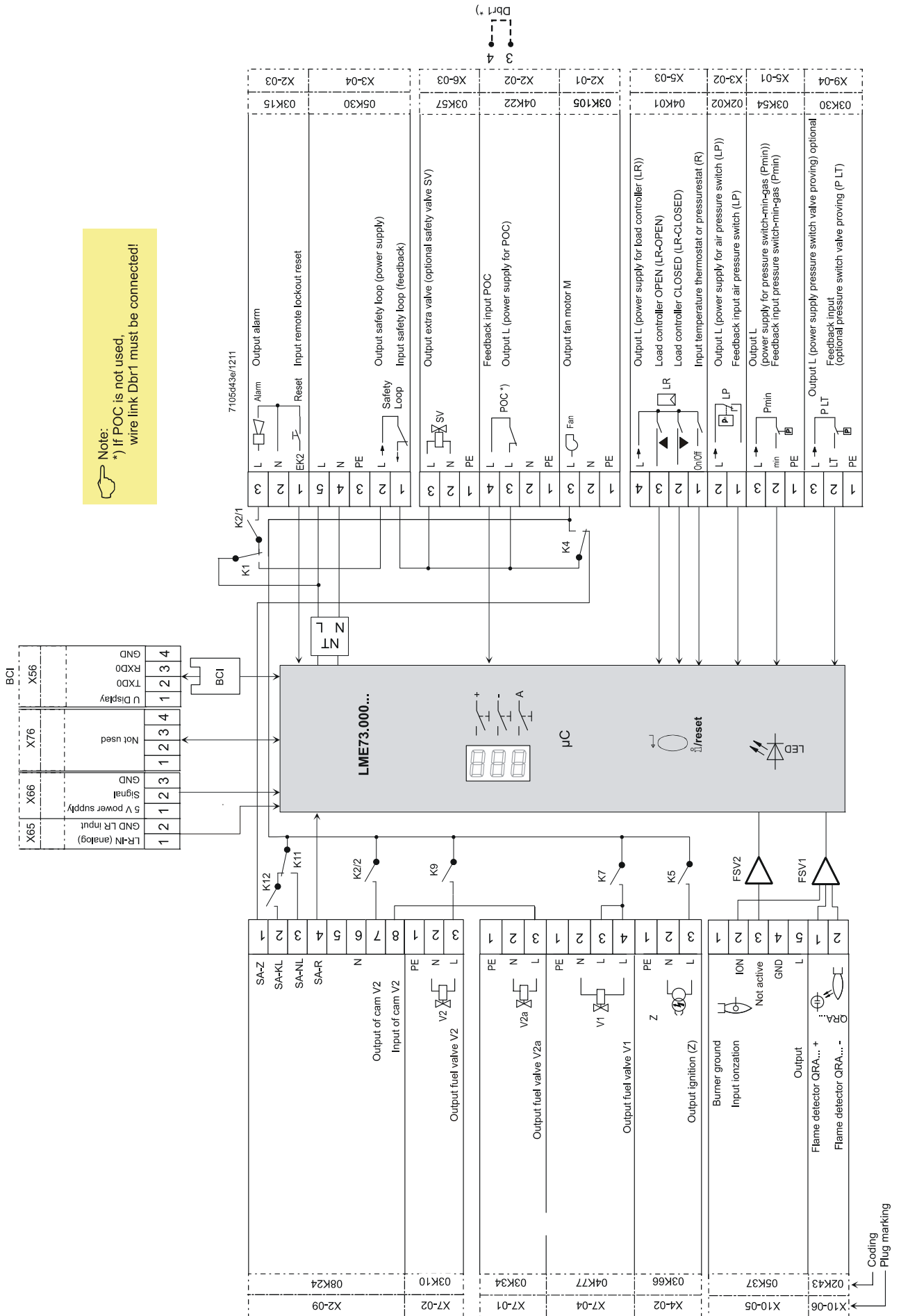

Connection diagram LME73... for PME73.830...

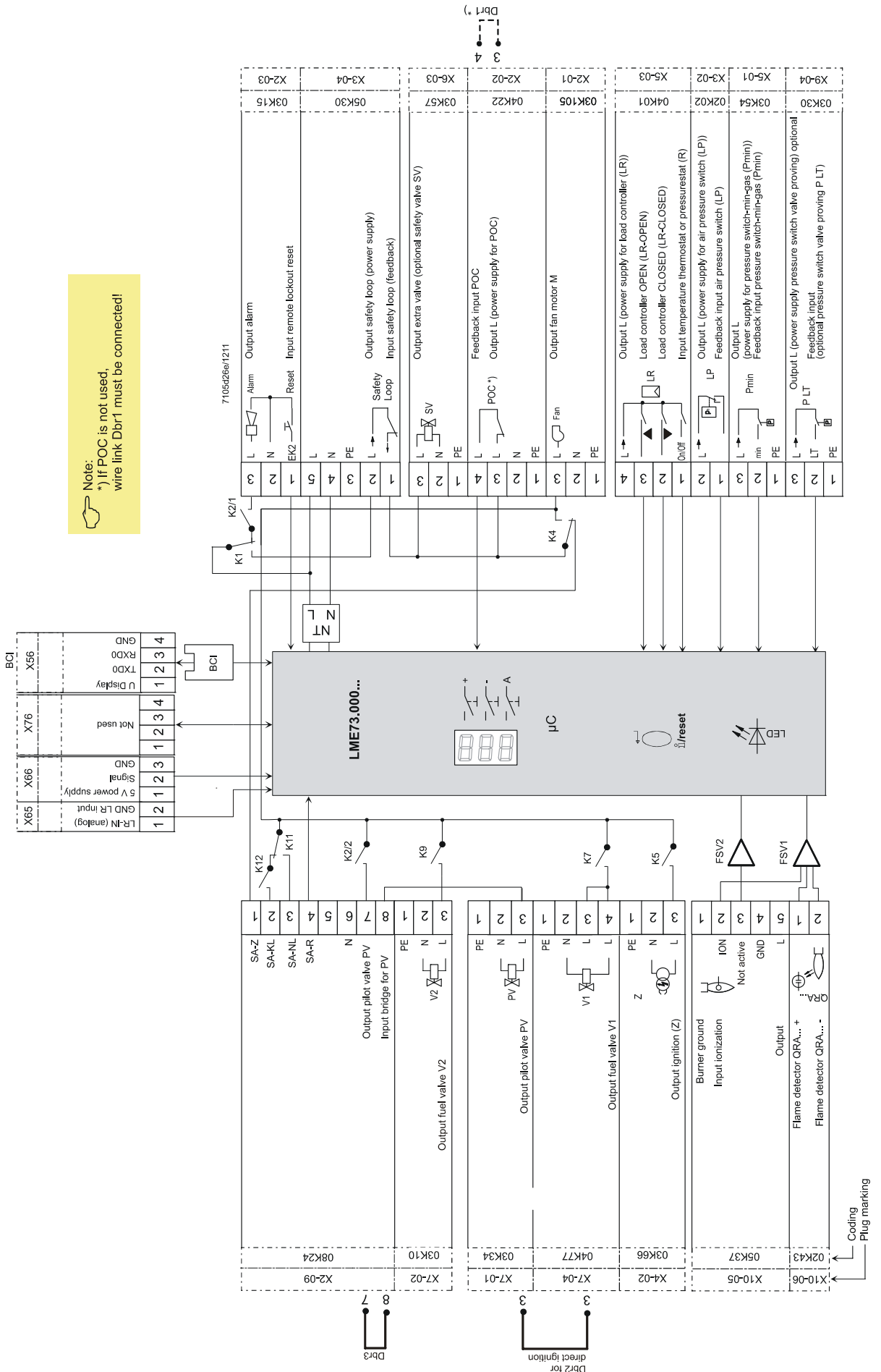



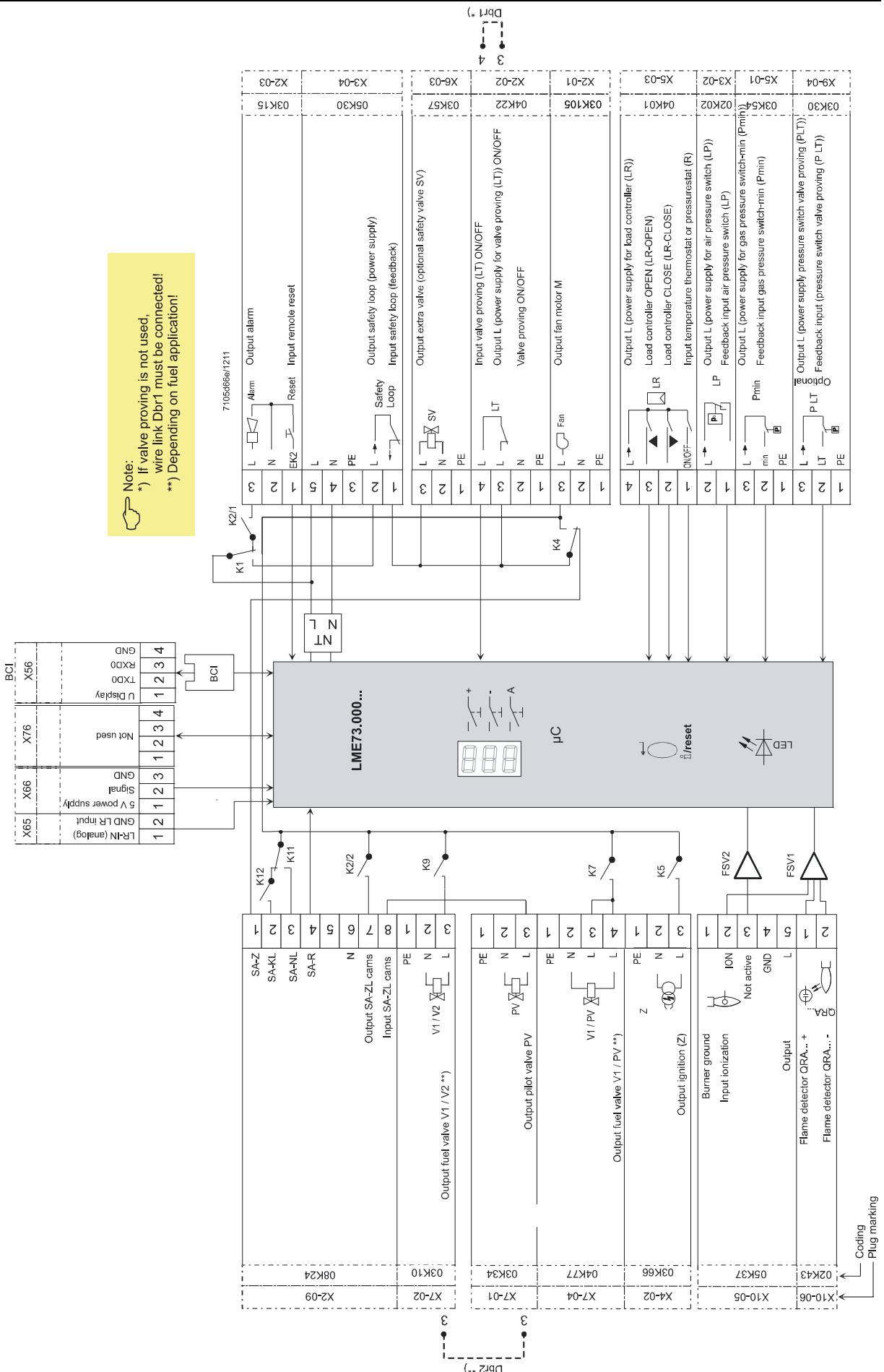

Connection diagram LME73... for PME73.831...

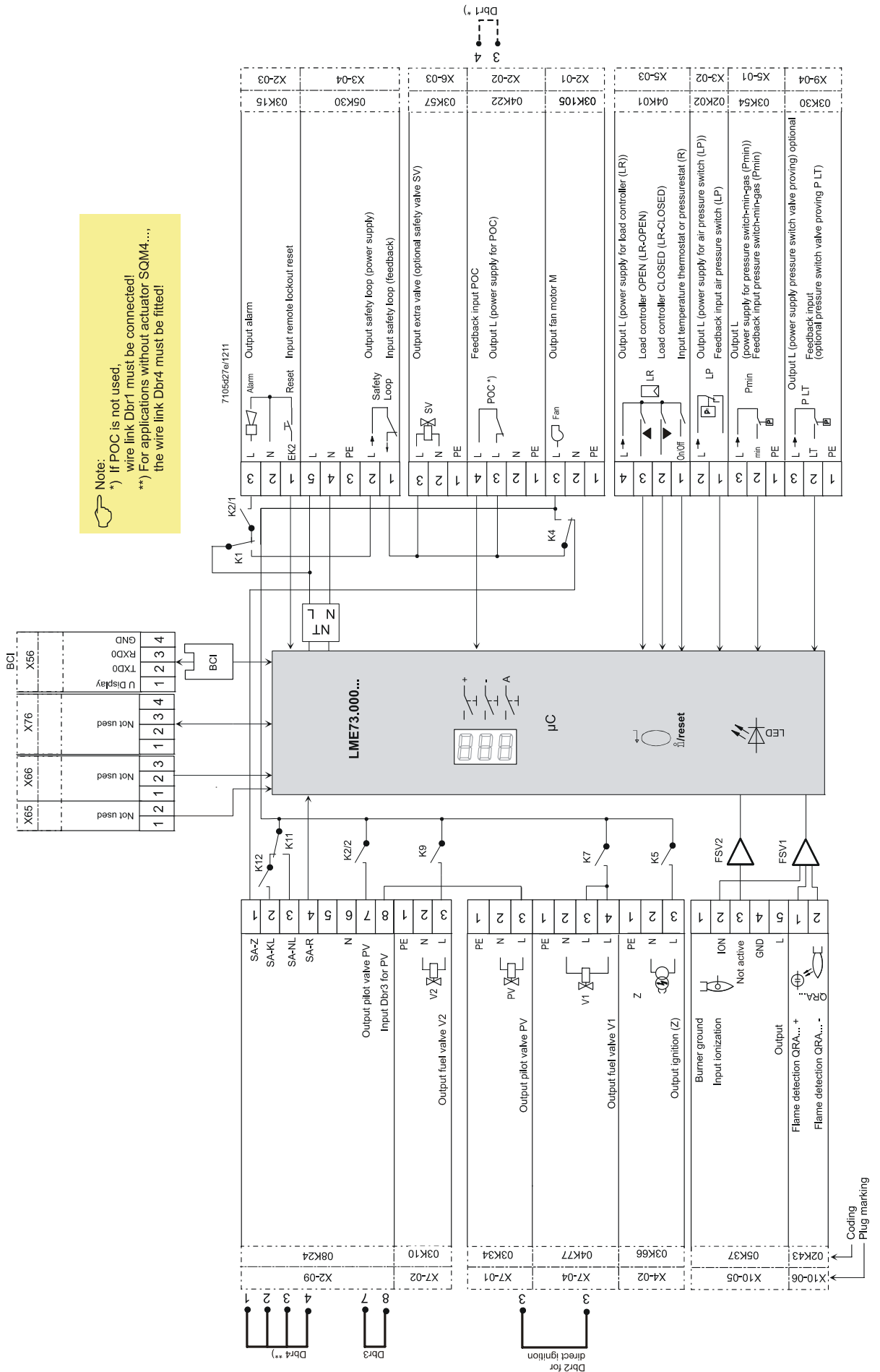

Connection diagram LME73... for PME73.840...



Legend

AL	Alarm device
AUX	Auxiliary output
Dbr	Wire link
 reset (EK1)	Lockout reset button (info button)
EK2	Remote lockout reset button
FSV	Flame signal amplifier
ION	Ionization probe
K...	Relay contact
LED	3-color signal lamp
LP	Air pressure switch
LR	Load controller
LR-OPEN	Load controller OPEN position
LR-CLOSE	Load controller CLOSE position
M	Fan motor
NT	Power supply unit
P LT	Pressure switch valve proving
Pmax	Pressure switch-max
Pmin	Pressure switch-min
POC	Proof of closure
PV	Pilot valve
QRA...	Flame detector
R	Control thermostat or pressurestat
SA	Actuator
SA-KL	Actuator low-fire
SA-NL	Actuator high-fire
SA-R	Actuator feedback
SA-Z	Actuator CLOSE
SA-ZL	Actuator ignition load
SL	Safety loop
STB	Safety limit thermostat
SV	Safety valve
V1	Fuel valve
V2	Fuel valve
V2a	Fuel valve
W	Limit thermostat or pressure switch
Z	Ignition transformer
μC	μC controller
	Input/output signal 1 (ON)
	Input/output signal 2 (OFF)
	Input permissible signal 1 (ON) or 0 (OFF)

Dimensions

Dimensions in mm

LME7...

